

# WELDING, CUTTING, HEATING & SAFETY

# ACCESSORIES



# ACCESSORIES



# TABLE OF CONTENTS

<b>Arc Welding Accessories . . . . .</b>	<b>3-6</b>	Clamps and Files . . . . .	9
Electrode Holders . . . . .	3	Marking Prodcuts . . . . .	10
Ground Clamps . . . . .	3-4	Tip Drills . . . . .	10
Cable Lugs . . . . .	4	Gas Saver . . . . .	10
Cable Splicers . . . . .	5	Tip Refacing Tool . . . . .	10
Cable Connectors . . . . .	5	Nozzle Reamer . . . . .	10
Machine Plugs . . . . .	6	<b>Hose Repair Kits . . . . .</b>	<b>11</b>
Connector Terminals . . . . .	6	<b>Crimping Tools . . . . .</b>	<b>11</b>
<b>Welding Accessories . . . . .</b>	<b>7-10</b>	<b>Hose Fitting, Ferrules &amp; Braces . . . . .</b>	<b>12</b>
Tip Cleaners . . . . .	7	<b>Safety Products . . . . .</b>	<b>13-14</b>
Cylinder Wrenches . . . . .	7	Ear Muffs . . . . .	13
Chipping Hammers . . . . .	7	Safety Goggle . . . . .	13
Magnetic Holders . . . . .	7	Welding Goggle . . . . .	13-14
Strikers & Replacement Flints . . . . .	8	Replacement Filters & Cover Plates . . . . .	14
Welding Hoses . . . . .	8	<b>Catalog Index . . . . .</b>	<b>15</b>
Brushes . . . . .	8		

## ONE YEAR DEFECTIVE REPLACEMENT WARRANTY

All **GENTEC** manufactured welding accessories are warranted to be free from defective material and workmanship for a period of one year from the date of purchase. Any GENTEC accessory found to be defective either in material or workmanship during that time will be replaced by your distributor, provided that said accessory was used under normal conditions for the purpose intended. Simply return the defective item to your distributor and he'll replace it, free of charge. It's that easy!

**GENTEC** accessories damaged or rendered inoperative due to abnormal wear and tear or abuse is not covered by this warranty and must be repaired at the sole expense of the equipment owner. **GENTEC** accessories should be serviced or repaired by qualified persons or repair stations only. Service or repair of this accessory by other than qualified service personnel may void any warranties and relieve **GENTEC** of any claims for damage and/or liability.

There are no other warranties, expressed or implied, except as stated herein. There are no warranties of merchantability or fitness for a particular purpose, which are specifically disclaimed. This warranty gives you specific legal rights, and you may also have other rights which vary from state to state.

**GENTEC** reserves the right to discontinue manufacturing of any product or change product materials, design or specifications without notice.

**WARNING:**  
**GENTEC** products should only be used by well-trained professional technicians. Misuse of these products could cause serious injuries or death.

**NOTE:** Specifications, data and availability of the products in this catalog are subject to change without notice.

# ARC WELDING ACCESSORIES

## ELECTRODE HOLDERS, GROUND CLAMPS

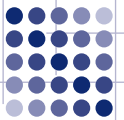

**GENTEC Electrode Holders** feature high copper alloy construction offering the optimum conductivity. Molded from high impact, high temperature fiberglass compound, the tip insulators will withstand intensive heat and impact. Holder handles are made from a vulcanized fiber material that offers superior insulation and impact resistance. The powerful spring, which is protected by a tough polycarbonate cup insulator, holds the electrode securely in place and prevents electrode slippage. The EH Series electrode holders provide a low profile design that allows for a more comfortable feel in the welder's hand and easy fit into tight areas. With higher upper lever, the EHT Series electrode holders provide much more hand clearance for welder preference. Ball-joint cable connection is also featured in EHT series.



**EH Series**



**EHT series**



**27-EHT-4TT**

Duty	Amperage Capacity	Model Number	LENCO® Equivalent	Cable Capacity	Electrode Capacity	Length	Weight
LIGHT DUTY	150-200	27-EH-1	AF-1	1	5/32"	8-3/8"	12.5 oz.
	200-250	27-EH-2	AF-2	1/0	5/32"	8-3/8"	12.5 oz.
MEDIUM DUTY	250-300	27-EH-25	AF-25	2/0	3/16"	8-3/4"	17.5 oz.
	300-350	27-EH-3	AF-3	2/0	1/4"	9-1/2"	25 oz.
HEAVY DUTY	350-400	27-EH-35	AF-35	3/0	1/4"	10-3/8"	25 oz.
	450-500	27-EH-50	AF-5	4/0	3/8"	11-1/2"	31.5 oz.

Duty	Amperage Capacity	Model Number	TWECO® Equivalent	Cable Capacity	Electrode Capacity	Length	Weight
LIGHT DUTY	200-250	27-EHT-2	A-532	BALL-POINT- 2/0	5/32"	8-1/2"	1 lb.
	250-300	27-EHT-25	A-316	BALL-POINT- 2/0	3/16"	9-1/4"	1 lb.
MEDIUM DUTY	300-350	27-EHT-3	A-732	BALL-POINT- 2/0	7/32"	10"	1.6 lbs.
	350-400	27-EHT-35	A-14	BALL-POINT- 4/0	1/4"	11"	1.9 lbs.
HEAVY DUTY	400-450	27-EHT-40	A-14-HD DOUBLE BALL-POINT-	4/0	1/4"	12"	1.16 lbs.
	450-500	27-EHT-50	A-38-HD DOUBLE BALL-POINT-	4/0	3/8"	13-1/4"	1.16 lbs.

Duty	Amperage Capacity	Model Number	TWECO® Equivalent	Cable Capacity	Electrode Capacity	Length	Weight
HEAVY DUTY	400-450	27-EHT-4TT	4TT	3/0	1/16" - 1/4"	9"	1.25 lbs.

**GENTEC GC Series Ground Clamps** feature a rugged all steel body with heavy duty springs and circular "Grabbers", copper alloy jaw, for a superior "grip" and "ground" on pipes, angle iron, plate and miscellaneous odd shapes. Pure copper braided shunt on model 27-GC500 allow both jaws to carry welding current. GCT Series Ground Clamps feature copper alloy jaws and fully insulated spring.



**27-GCT300C**



**27-GC300**



**27-GC500**

Model Number	Amperage Capacity	Description	Cable Capacity	Equivalent To	Jaw Opening	Length
27-GC200	200	STEEL BODY, COPPER JAW	1/2" STUD CONNECTION	LENCO® EG-200	1-1/2"	7"
27-GC300	300	STEEL BODY, COPPER JAW	1/2" STUD CONNECTION	LENCO® EG-300	2"	8"
27-GC500	500	STEEL BODY, COPPER SHUNT	1/2" STUD CONNECTION	LENCO® EG-500	2"	9-1/2"
27-GCT200C	200	COPPER, INSULATED SPRING	BALL-POINT- 1/0	TWECO® GC-200	1"	6"
27-GCT300C	300	COPPER, INSULATED SPRING	BALL-POINT- 3/0	TWECO® GC-300	1-1/2"	8"
27-GCT500C	500	COPPER, INSULATED SPRING	BALL-POINT- 4/0	TWECO® GC-500	2"	10"

LENCO® is a registered trademark of NLC, Inc.. TWECO® is a registered trademark of Tweco Products, Inc.. These companies are not associated with Genstar Technologies Co., Inc.



# ARC WELDING ACCESSORIES

## ROTARY-WORK GROUND CLAMPS AND CABLE LUGS

### GROUND CLAMPS

**GENTEC GCF Series Ground Clamps** feature copper alloy flat jaw with heavy duty springs.

Model Number	Amperage Capacity	Description	Cable Capacity	TWECO® Equivalent	Jaw Opening	Length
27-GCF200C	200	COPPER, FLAT JAW	BALL-POINT- 4/0	FGC-200	5/8"	5
27-GCF300C	300	COPPER, FLAT JAW	BALL-POINT- 4/0	FGC-300	1"	7-1/4"
27-GCF500C	500	COPPER, FLAT JAW	BALL-POINT- 4/0	FGC-500	1-1/2"	9"



### ROTARY-WORK GROUND CLAMPS

**GENTEC Rotary-Work Ground Clamps** are designed for high amperage grounding work in combination with rotary grounding devices. It saves welding down time by quick attachment and movement from one weldment to the other without removing the rotary grounding devices. They are made from 98% copper alloy. Models 27-GCR600 and 27-GCR1200 have a single tightening screw. Model 27-GCR2000 has two tightening screws.

Model Number	Amperage Capacity	Throat Height	Throat Depth	Fits TWECO® Rotary Ground Devices	Clamp Contact	Height	Length
27-GCR600	600	2-1/2"	2-1/2"	RG-230	6.25 Sq. Inch	5-3/4"	2-1/2"
27-GCR1200	1200	3"	3"	RG-240 / RG-440	9 Sq. Inch	6-3/4"	3"
27-GCR2000	2000	3"	3"	RG-440 / RG-640	12 Sq. Inch	6-3/4"	4"

### ROTARY-WORK GROUND CLAMP REPLACEMENT PARTS

Model Number	TWECO® Equiv.	Description
27-GCR1200-1	WCRG-1200-1	PRESSURE TIGHTENING SCREW FOR ALL ROTARY WORK CLAMPS
27-118	118	WORK CLAMP ADAPTER FOR 27-CGR600
27-138	138	WORK CLAMP ADAPTER FOR 27-CGR1200
27-118-1	118-1	HEX HEAD NUT FOR 27-118 & 27-138

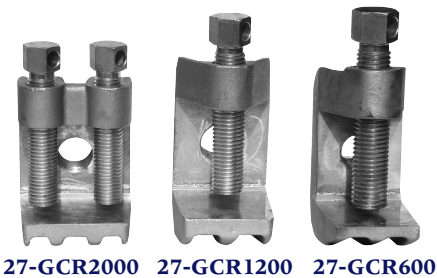

27-CL4045



27-CL1080



27-CLC4045



27-CLC1080

**GENTEC Ball-Point Connection Type Cable Lugs** are made from heavy duty cast copper alloy. They replace the ordinary solder type cable lugs for connecting welding cable to a welding machine.

Model Number	TWECO® Equiv.	Description	Model Number	TWECO® Equiv.	Description	Cable Capacity	Stud Hole
27-CL1045	10-45	45° ANGLE, W/O INSULATOR	27-CLC1045	10-45C	45° ANGLE, WITH INSULATOR	1/0	17/32"
27-CL1080	10-180	180° ANGLE, W/O INSULATOR	27-CLC1080	10-180C	180° ANGLE, WITH INSULATOR	1/0	
27-CL4045	40-45	45° ANGLE, W/O INSULATOR	27-CLC4045	40-45C	45° ANGLE, WITH INSULATOR	4/0	
27-CL4080	40-180	180° ANGLE, W/O INSULATOR	27-CLC4080	40-180C	180° ANGLE, WITH INSULATOR	4/0	

**GENTEC Crimp/Solder Type Cable Lugs** are made from copper alloy. Extra long barrel provides easy soldering or attachment by crimping tool. Flared end provides easy cable access.

### WELDING CABLE LUGS

Model Number	TWECO® Equiv.	Cable Size	Stud Hole	Barrel I.D.
27-CL26	LENCO	2-6	21/64"	0.344
27-CL62	T-62	2-6	17/32"	0.461
27-CL12	LENCO L-12	1-2	17/32"	0.402
27-CL120	T-12	1-2/0	17/32"	0.559
27-CL3040	T-3040	3/0 - 4/0	17/32"	0.660
27-CL40HD	T-40HD	4/0 HD	21/32"	0.776

### POWER CABLE LUGS

Model Number	TWECO® Equiv.	Cable Size	Stud Hole	Barrel I.D.
27-CL1214	T-1214	12-14	13/64"	0.186
27-CL810	T-810	8-10	13/64"	0.238
27-CL68	T-68	6-8	21/64"	0.289
27-CL46	T-46	4-6	21/64"	0.347



Tweco® is a registered trademark of Tweco Products, Inc. which is not associated with Genstar Technologies Co., Inc.

# ARC WELDING ACCESSORIES

## CABLE SPLICERS & SLEEVES, CABLE CONNECTORS

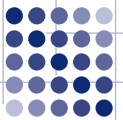

**GENTEC Ball-Point Type Cable Splicers** provide easy cable splicing by using large ball-point screws on each end of the splicer. Cable splicers are insulated with fiber sleeves.

Model Number	LENCO® Equivalent	Cable Size
27-CSB610	CS-610	6-1/0
27-CSB2040	CS-2030	2/0-4/0
27-CSB3040	CS-3040	3/0-4/0

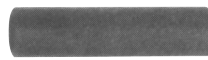

27-CSB610

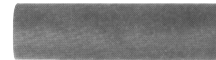

27-CSB2040



27-CSB3040

**GENTEC Welding Cable Splicers** are made from quality copper tubes. They are attached to the welding cable by using a block and punch tool. They are ideal for making repairs or adding additional length to cables. Rubber Sleeves are also available for proper insulation.

### CABLE SPLICERS

Model Number	TWECO® Equivalent	Cable Size	Splicer Tube I.D.
27-CS62	TS-62	6-2	0.460"
27-CS120	TS-120	1-2/0	0.599"
27-CS3040	TS-3040	3/0-4/0	0.660"
27-CS40HD	TS-40HD	4/0 HEAVY DUTY	0.776"

### RUBBER SLEEVES

Model Number	TWECO® Equivalent
27-CSS62	TS-62RS
27-CSS120	TS-120RS
27-CSS3040	TS-3040RS
27-CSS40HD	TS-40HDRS



27-CS62



27-CSS62

**GENTEC Cable Connectors** feature a twist "POSI-LOOK" cam that pulls two halves together firmly for a positive connection. The connectors are precision machined from specially extruded brass bar stock. The insulator covers are molded from a high heat and impact resistant black plastic. Connectors are compatible with certain models from other manufacturers.



27-CC10



27-CC40

Model Number	Color	Model Number	Color
27-CC10	BLACK	27-CCR10	RED
27-CC10F	BLACK	27-CCR10F	RED
27-CC10M	BLACK	27-CCR10M	RED
27-CC40	BLACK	27-CCR40	RED
27-CC40F	BLACK	27-CCR40F	RED
27-CC40M	BLACK	27-CCR40M	RED

Description	LENCO® Equivalent	Cable Capacity	Length	Weight
COMPLETE SET	LC-10	4-1/0	9-3/4"	7 oz.
FEMALE HALF	LC-10	4-1/0	5"	3 oz.
MALE HALF	LC-10	4-1/0	6"	4 oz.
COMPLETE SET	LC-40	1/0-2/0	9-3/4"	10-1/2 oz.
FEMALE HALF	LC-40	1/0-2/0	5"	5 oz.
MALE HALF	LC-40	1/0-2/0	6"	5-1/2 oz.

### MODEL 27-CCW1040 WHIP CABLE CONNECTOR

- Male plug fits female 27-CC40F and 27-CCR40F connectors
- Single ball-point cable connection
- Cable hole accepts cable size up to No. 1/0
- Weight: 6 oz.

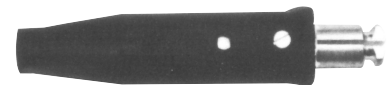

27-CCW1040

LENCO® is a registered trademark of NLC, Inc.. TWECO® is a registered trademark of Tweco Products, Inc.. These companies are not associated with Genstar Technologies Co., Inc.



# ARC WELDING ACCESSORIES

## MACHINE PLUG AND ADAPTER, CONNECTOR TERMINAL

**GENTEC Machine Plugs** feature fast and secure ball-point connection to fit most welding machines that use long tapered plug and receptacle. Two types of machine plugs are available. Model 27-MP10M fits MILLER®'s welding machines and model 27-PM10 fits others, such as FORNEY CENTURY and POWERMATE. Both models come with black covers.

Model Number	LENCO® Equivalent	Cable Capacity	Taper Length	Taper Dimension
27-MP10M	LC-10MP	4-1/0	1.063"	0.330" - 0.353"
27-MP10	UP-10	4-1/0	1.000"	0.365" - 0.385"



27-MP10



27-MP10M

**GENTEC International DINSE Type Machine Plugs** are designed for use with No. 8 through No. 4/0 AWG size cable. Model 27-LDA one-piece adapter has a DINSE style male plug for connecting a power source on one end and a US style female socket (27-CC40F/27-CCR40F) to the other end.

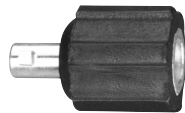

27-MPD-LDA

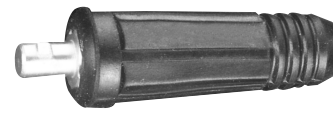

27-MPD50

Model Number	LENCO® Equivalent	Cable Capacity	Male End Dia.	Cable Connect.	Dinse	ESAB®	Interchangeable With				
							KEMPPi®	LINCOLN®	M.K.	MILLER®	POWCON®
27-MPD25	LPD-25M	8 - 4	0.355"	S. BALL-POINT	DIX SK 25	160360895	9771650	S19301-6	N/A	N/A	N/A
27-MPD50	LPD-50M	4 - 1/0	0.508"	S. BALL-POINT	DIX SK 50	N/A	9771670	N/A	N/A	042-418	930008-001
27-MPD70	LPD-70M	1/0 - 2/0	0.508"	S. BALL-POINT	DIX SK 70	13792513	9771680	K-852-70	153-0755	042-533	N/A
27-MPD95	LPD-95M	3/0 - 4/0	0.508"	D. BALL-POINT	DIX SK 95	13792513	N/A	K-852-95	N/A	042-574	N/A
27-MPD-LDA	LDA		0.508"		N/A	N/A	N/A	N/A	N/A	042-465	N/A

**GENTEC Connector Terminals** provide fast connection and disconnection of welding cable to the welding machines. They replace ordinary solder-type lugs and provide secure attachment to the stubs of the welder.

Model Number	LENCO® Equivalent	Fits Connector	Angle	Stub Hole Diameter
27-CT10FA	CT-10FA	27-CC(R)10M	45°	17/32"
27-CT10FS	CT-10FS	27-CC(R)10M	180°	17/32"
27-CT40FA	CT-40FA	27-CC(R)40M	45°	17/32"
27-CT40FS	CT-40FS	27-CC(R)40M	180°	17/32"



27-CT10FA

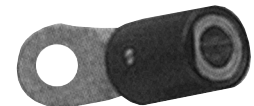

27-CT40FA

ESAB® is a registered trademark of ESAB Welding & Cutting Products. KEMPPi® is a registered trademark of KEMPPi International. LENCO® is a registered trademark of NLC, Inc.. Lincoln® is a registered trademark of Lincoln Global Inc.. MILLER® is a registered trademark of MILLER Group Limited, Corp.. POWCON® is a registered trademark of Cyclomatic Industries, Inc.. Tweco® is a registered trademark of Tweco Products, Inc.. These companies are not associated with Genstar Technologies Co., Inc.

# WELDING ACCESSORIES

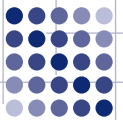

## TIP CLEANERS, CYLINDER WRENCHES, CHIPPING HAMMERS & MAGNETIC HOLDERS

**GENTEC “WIRE-O” Tip Cleaner Sets** feature blue anodized aluminum cover and stainless steel wire tapered ends for easy entry and uniform ridges for optimum cleaning. “Wire-O” standard size cleaners are 5/8” longer for more efficient cleaning of longer channels. “Wire-O” cleaners are excellent for cleaning clogged orifices in sprinklers, shower heads, gas range burners, windshield washers, etc.

Model Number	Description	Number of Wires	Wire length	Wire Sizes	Drill Sizes
25-120	STANDARD	13	2-3/4”	6-26	77-49
25-121	MASTER	21	2-3/4”	1-21	77-49
25-122	JUMBO	9	2-3/4”	13-21	77-49
25-130	KING SIZE	13	4-1/2”	6-26	77-49

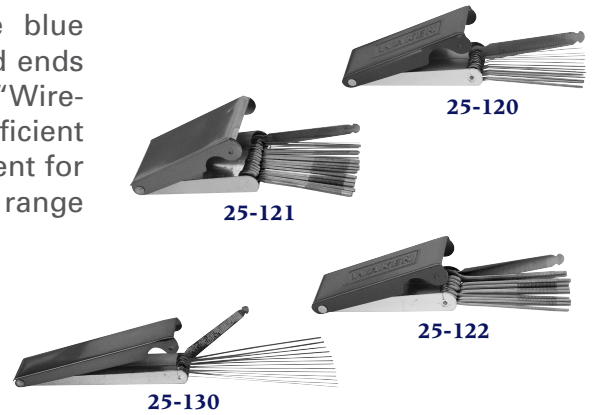

**GENTEC Cylinder Wrenches** are drop forged, special alloy steel for maximum durability. Their “Baked” black powder coated finish prevents rusting and enhances their appearance.

The No. 5 “B” MC key, because of its size, is cadmium plated (silver in color), which also prevents rusting. The No. MCW-3P medical post valve wrench is black plastic. Truly, the finest wrenches of their kind in the industry.

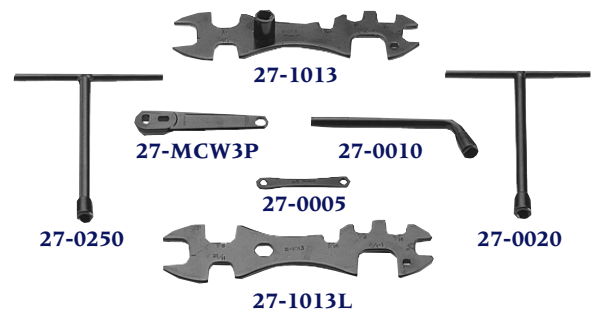

Model Number	Item Number	Description	ATLAS® Equiv.
27-1013	1013	TEN MOUTH; 10 WAY CGA WRENCH W/SOCKET FOR COMMERCIAL ACETYLENE; 3/8” SOCKET (ACTUAL .390)	A-1013
27-1013L	1013L	NINE MOUTH; 9 WAY CGA WRENCH FOR NON-FUEL GAS & LINDE TYPE ACETYLENE GAS USERS	
27-0250	250	LIN-T; 6’ LONG T-HANDLE FOR LINDE ACETYLENE VALVE; 9/32” SOCKET (ACTUAL .290)	250
27-0020	20	COM-T; 6” LONG T-HANDLE FOR COMMERCIAL ACETYLENE VALVE; 3/8” SOCKET (ACTUAL .390)	20
27-0010	10	L-COM; 5” LONG L-HANDLE FOR COMMERCIAL ACETYLENE VALVE; 3/8” SOCKET (ACTUAL .390)	10
27-0005	5	B-KEY; 3-1/8” LONG BOX WRENCH FOR B & MC CYLINDERS; 3/16” BOX (ACTUAL .194), CADMIUM PLATED	5
27-MCW-3P	MCW-3P	MEDICAL; POST VALVE WRENCH, NON-METALLIC	

**GENTEC Chipping Hammers** feature drop forged, heat treated heads that are welded to a tough steel shaft. Their “Baked” black powder-coated finish prevents rusting and enhances their appearances. Both steel coil spring and wood handles are available.

Model Number	Description	Lenco® Equiv.	ALTAS® Equiv.
25-HG-20	CONE & CHISEL, COIL HANDLE	LH-2	S-20
25-HG-20WB	CHISEL, WIRE BRUSH, COIL HANDLE	LA-1	A
25-HG-21WD	CONE & CHISEL, WOOD HANDLE	LHW-1	J
25-HG-30	CONE & CROSS CHISEL, COIL HANDLE	LHC-2	S-30



**GENTEC Magnetic Holders** are designed to hold any ferrous metal at 45, 90 and 135 degrees for welding, soldering, pipe installation, assembly, etc.

Model Number	Size
25-M060P	SMALL
25-M061P	MEDIUM
25-M063P	LARGE
25-M065P	EXTRA LARGE

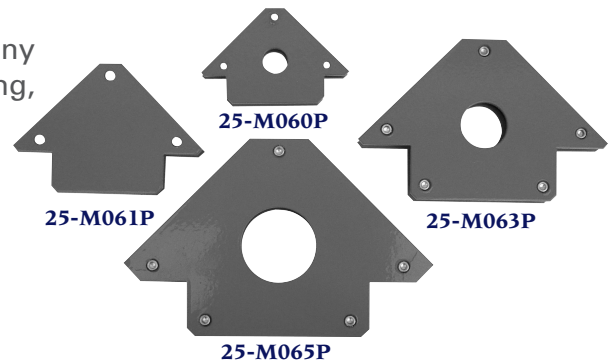

ATLAS® is a registered trademark of Atlas Welding Accessories Inc.. Lenco® is a registered trademark of NLC, Inc.. These companies are not associated with Genstar Technologies Co., Inc.



# WELDING ACCESSORIES

## STRIKERS, TWIN WELDING HOSES AND BRUSHES

### GENTEC STRIKERS & REPLACEMENT FLINTS

Model Number	Description
25-300	SINGLE FLINT LIGHTER
25-301	SINGLE FLINT RENEWALS, 5/CD
25-450	TRIPLE FLINT SPARK LIGHTER
25-451	TRIPLE FLINT RENEWALS



25-300



25-301



25-450



25-451

### GENTEC TWIN WELDING HOSE, RUBBER, GRADE R

Model Number	Hose I.D.	Hose Length
HW23-012	3/16"	12.5'
HW23-020	3/16"	20'
HW23-025	3/16"	25'
HW23-050	3/16"	50'

Model Number	Hose I.D.	Hose Length
HW24-025	1/4"	25'
HW24-050	1/4"	50'
HW24-100	1/4"	100'



### GENTEC HEAVY-DUTY BRUSHES

GENTEC Heavy-Duty Brushes are made of high quality wires and hard wood for handles.

#### UTILITY BRUSHES

Model Number	Description
28-15SS	STAINLESS STEEL, HARD TIED
28-30SS	STAINLESS STEEL, STAPLED FILL



#### BUTCHER BLOCK BRUSH

Model Number	Description
28-B290	CARBON STEEL, 5 X 10 ROW

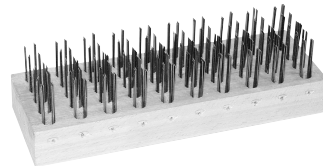

#### BENT HANDLE BRUSHES

Model Number	Description
28-B388	CARBON STEEL, 3 X 19 ROW
28-B388SS	STAINLESS STEEL, 3 X 19 ROW

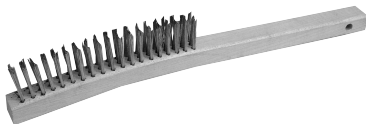

#### SHOE HANDLE BRUSHES

Model Number	Description
28-B387	CARBON STEEL, 4 X 16 ROW
28-B387SS	STAINLESS STEEL, 4 X 16 ROW

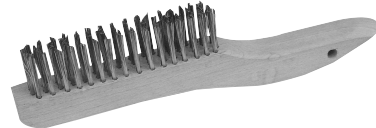

#### CHIPPING HAMMER BRUSH

Model Number	Description
28-BA19	CARBON STEEL, 3 X 15 ROW

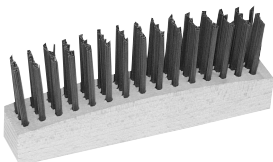

#### ACID BRUSH

Model Number	Description
28-BAB06	#2 HORSEHAIR, 6" LENGTH, 50/PACK





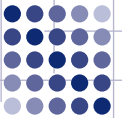

**GENTEC Locking Plier C-Clamps** are designed for clamping odd-size materials together during welding processes such as auto repair, etc. The large throat locking C-clamp is made of high quality steel, featuring: A micro adjusting screw for jaw opening change, guarded easy release trigger for quick release, and non-slip locking grip.

Model Number	Size	Jaw Adjustment	Throat Depth
28-CLP06	6"	0 - 2-1/8"	1-1/2"
28-CLP11	11"	0 - 4"	2-5/8"



**GENTEC Locking Plier Welding Clamp** features U-shaped and deep throat for clamping odd-sized materials together and in proper alignment, micro adjusting screw for jaw opening change, guarded easy release trigger for quick release, and non-slip locking grip. (Length: 9", Jaw Width: 2-3/4"). **Model 28-CLW09**



**GENTEC 90° Angle Vise Clamps** These high quality cast-iron constructed vise clamps feature self-centering jaw for quick adjustment to clamp materials of different sizes, slotted hole in base for convenient mounting, and copper plated spindle for securely gripping parts at 90°.

Model Number	Maximum Opening	Jaw Height	Jaw Depth
28-CLV90-1	2.36"	1.38"	2.36"
28-CLV90-2	3.94"	4.13"	4.92"

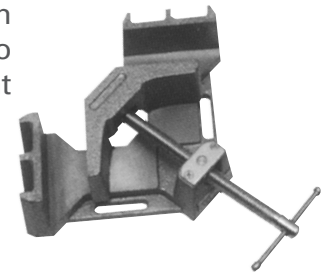

**GENTEC Drop Forged C-Clamps** feature heavy-duty copper-plated screw, handle, and ball joint swivel foot pad. They are spatter and corrosion resistant. Excellent for welding.

Model Number	Size
28-CL402	2"
28-CL403	3"
28-CL404	4"
28-CL406	6"
28-CL408	8"
28-CL410	10"
28-CL412	12"

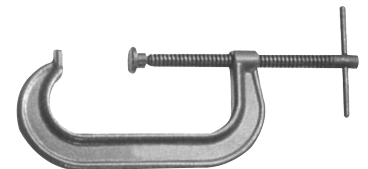

**GENTEC 14" Half-Round and Pipeliner Files** are heat treated during manufacturing to ensure high quality.

Model Number	Description
25-FB14HR	1/4" HALF ROUND BASTARD FILE
25-FP14	14" PIPELINER FILE





# WELDING ACCESSORIES

MARKING PRODUCTS, TIP DRILLS, TIP REFACING TOOL, NOZZLE REAMERS, GAS SAVERS

## GENTEC SOAPSTONE HOLDERS

Model Number	Description
25-FSH10	FLAT SOAPSTONE HOLDER, WITH SOAPSTONE
25-FSH30	ROUND SOAPSTONE HOLDER, WITH SOAPSTONE



## GENTEC MODEL 25-TD3 TIP DRILL SET

- Contains 12 high carbon steel drills
- Size: 52 through 74



## GENTEC MODEL 25-110 TIP REFACING TOOLS

- Refaces damaged tips to original condition
- Fits most tips



## GENTEC MODEL 27-NR MIG REAMER

- Clean inside surface of most welding nozzles

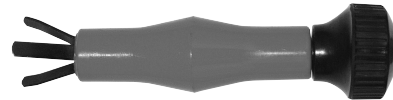

## GENTEC GAS SAVERS

Double Shutoff Valves with Pilot Flame are designed for quick shut-off and easy restart of the working flame during gas welding and cutting operation. The working flame is automatically extinguished and the gas flow discontinued by placing the torch handle on the convenient hook. To reignite the working flame, lift the torch handle from the hook and place the tip close to the pilot flame. Our Duel Shutoff Valve Assembly is convenient, safe and fuel-efficient.

Model 100QF-Y for Acetylene

Model 100QF-F for Fuel Gas

Maximum Pressure: Oxygen 150 PSI, Fuel Gas 22 PSI

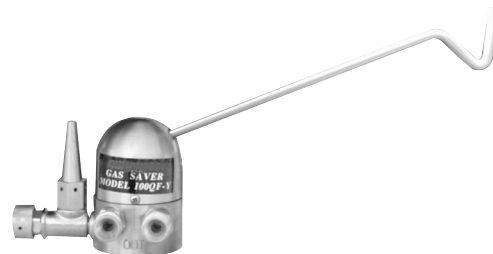

# HOSE REPAIR KITS AND CRIMPING TOOLS

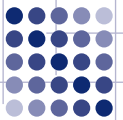

**GENTEC Hose Repair Kits** are designed and outfitted to allow timely hose repair in the shop or in the field. A tough polyethylene case holds the components: Hose nuts and nipples (A & B sizes), splicers, couplers and various size ferrules most commonly used on 3/16" and 1/4" hose. Kits are available with 2 types of tools (see below). A display card with the fitting numbers and the compartment location is on both the outside and inside of the case lid for added convenience in selecting and reordering. Plastic case (CK-0) is also available separately.



## KITS WITH "A" AND "B" TYPE FITTINGS - ITEM NUMBERS INCLUDED IN KITS

Kit Number	#C-1 QTY.	#C-5 QTY.	#7 QTY.	#8 QTY.	#9 QTY.	#10 QTY.	#17 QTY.	#18 QTY.	#19 QTY.	#30 QTY.	#31 QTY.	#44 QTY.	#45 QTY.	#130 QTY.	#131 QTY.	#769 QTY.	#7325 QTY.	#7326 QTY.
CK-1SP	1	--	8	8	4	4	10	6	8	1	1	4	2	1	1	12	10	10
CK-5SP	--	1	8	8	4	4	10	6	8	1	1	4	2	1	1	12	10	10

## KITS WITH "B" TYPE FITTINGS ONLY - ITEM NUMBERS INCLUDED IN KITS

Kit Number	#C-1 QTY.	#C-5 QTY.	#7 QTY.	#8 QTY.	#17 QTY.	#18 QTY.	#30 QTY.	#31 QTY.	#44 QTY.	#45 QTY.	#769 QTY.	#4750 QTY.	#7325 QTY.	#7326 QTY.
CK-20SP	1	--	6	6	6	6	2	2	4	4	8	6	6	8
CK-24SP	--	1	6	6	6	6	2	2	4	4	8	6	6	8

## KITS WITH 1/4" FITTINGS ONLY - ITEM NUMBERS INCLUDED IN KITS

Kit Number	#C-1 QTY.	#C-5 QTY.	#7 QTY.	#8 QTY.	#17 QTY.	#30 QTY.	#31 QTY.	#44 QTY.	#3588 QTY.	#7325 QTY.	#7326 QTY.	#9940-P QTY.
CK-22SP	1	--	6	6	12	2	2	4	6	4	12	3
CK-26SP	--	1	6	6	12	2	2	4	6	4	12	3

Kit Box (empty), CK-0 (13 Compartment), is available.

**GENTEC Crimping Tools** are ideal for shop and field repair of hoses. They are made of high alloy, nickel plated steel, with a one piece forged jaw for super strength.



C-1



C-5

Model Number	Description
C-1	3/16", 1/4" HAMMER OR VISE TYPE
C-5	3/16", 1/4" V-GRIP PLIER TYPE



# HOSE FITTINGS, FERRULES & BRACES

GENTEC Hose Fittings, Ferrules & Braces are high quality brass, accurately machined to applicable CGA specifications. Ferrules and braces are stamped from brass. The part number is stamped on each ferrule and brace for easy identification.

## BRASS HOSE NUTS, NIPPLES, COUPLERS & SPLICERS

### PRESSURES UP TO 200PSI (1400kPa)

#### A-SIZE NUTS AND A-SIZE COUPLERS

3/8"-24 UNF-2B



OXYGEN, RH NO. 9



OXYGEN, RH NO. 130



FUEL, LH NO. 10



FUEL, LH NO. 131

#### A-SIZE NIPPLES

(USE WITH NO. 9 & NO. 10 NUTS)



3/16" I.D. HOSE NO. 19

#### B-SIZE NUTS AND B-SIZE COUPLERS

9/16"-18 UNF-2B



OXYGEN, RH NO. 7

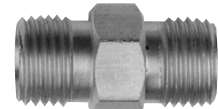

OXYGEN, RH NO. 30

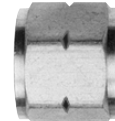

FUEL, LH NO. 8

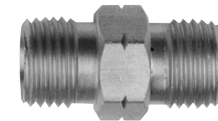

FUEL, LH NO. 31

#### B-SIZE NIPPLES

(USE WITH NO. 7 & NO. 8 NUTS)



3/16" I.D. HOSE NO. 18



1/4" I.D. HOSE NO. 17

#### HOSE SPLICERS



3/16" I.D. HOSE - 3/16" I.D. HOSE NO. 45

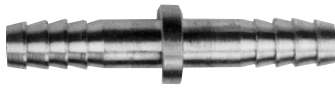

1/4" I.D. HOSE - 1/4" I.D. HOSE NO. 44

#### ORDER INFORMATION

Item Number	Order Number
7	24-0007
8	24-0008
9	24-0009
10	24-0010
17	24-0017
18	24-0018
19	24-0019

Item Number	Order Number
30	24-0030
31	24-0031
44	24-0044
45	24-0045
130	24-0130
131	24-0131

## BRASS FERRULES & HOSE BRACES

No. 769



No. 4750



No. 3588

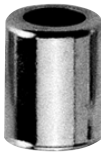

No. 7325



No. 7326

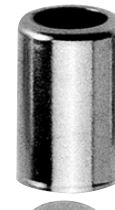

No. 9940-P

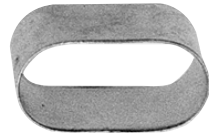
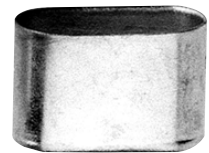

Item Number	Order Number	Ferrule I.D.	Ferrule Length	Item Number	Order Number	Ferrule I.D.	Ferrule Length
769	24-0769	.450"	9/16"	7326	24-7326	.593"	1"
3588	24-3588	.564"	3/4"	7327	24-7327	.625"	1"
4750	24-4750	.478"	11/16"	7328	24-7328	.656"	1"
7322	24-7322	.500"	1"	7329	24-7329	.687"	1"
7323	24-7323	.525"	1"	9116	24-9116	3/16" HOSE BRACE	
7325	24-7325	.562"	1"	9440-P	24-9440P	1/4" HOSE BRACE	

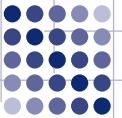

### MODEL 20-EP-106 MULTI-POSITION EAR MUFF

Features three-position adjustable low-pressure headband and large ear cup with soft PVC leather ear cushions for excellent protection and a snug and comfortable fit. The adjustable, flexible plastic reinforced headband ensures a secure fit and allows the muff to be worn over the head, behind the head, or under the chin. Meets ANSI S3.19.

Frequency (Hz)	100	250	500	1000	2000	4000	8000
MEAN ATTENUATION (dB)	8.9	13.7	20.7	26.1	33.2	34.5	34.5
STANDARD DEVIATION (dB)	2.4	2.1	2.0	1.9	2.1	2.2	3.4



### MODEL 20-EP-107 FOLDABLE EAR MUFF

Features low-pressure headband and large ear cup with soft PVC leather for a snug and comfortable fit and excellent protection. This durable muff folds to a compact size for convenient storage. Meets ANSI S3.19

Frequency (Hz)	125	250	500	1000	2000	4000	8000
MEAN ATTENUATION (dB)	5.16	27.54	33.04	47.88	52.98	34.57	43.99
STANDARD DEVIATION (dB)	0.03	0.02	0.03	0.31	0.72	0.03	0.05



### MODEL 20-G202C IMPACT SAFETY GOGGLES

Features clear soft PVC frame for a snug and comfortable fit over the face or RX glasses. Clear and tough polycarbonate lens provide best vision and protection against flying particles. Perforations on each side and top provide direct ventilation. Meets ANSI Z87.1



### MODEL 20-G206C CHEMICAL SAFETY GOGGLES

Features clear soft PVC frame for a snug and comfortable fit over the face or RX glasses. Clear and tough polycarbonate lens provide best vision and protection against flying particles. Four indirect vents on bottom and top provides direct ventilation. Used for chemical splash, dust and impact protection. Meets ANSI Z87.1



### MODEL 9-WG1P WELDING GOGGLES

Features soft and flexible frame for a snug and comfortable fit over the face or RX glasses. Four indirect vents on the bottom and top provide effective air circulation. Shade no. 5 filter plates. Meets BS2092.1



### MODEL 20-1610-5 LIFT FRONT CUP-STYLE WELDING GOGGLES

Features lift front cups with replaceable 50mm shade 5 filter lens, clear cover glass lens, and clear protective polycarbonate lens. Soft and flexible frame provides a snug and comfortable fit over the face or RX glasses. Four indirect vents on the bottom and top provide effective air circulation. Also accommodates magnifier lenses. Meets ANSI Z87.1





# SAFETY PRODUCTS

## WELDING GOGGLES & REPLACEMENT FILTER

### MODEL 20-1675-5 FIXED-FRONT CUP-STYLE WELDING GOGGLES

Features fixed front cups with 50mm shade 5 filter lens and clear cover glass lens. Soft and flexible frame provides a snug and comfortable fit over the face or RX glasses. Four indirect vents on the bottom and top provide effective air circulation. Also accommodates magnifier lenses. Meets ANSI Z87.1



### MODEL 9-WG6G CUP GOGGLES

Features heat-resistant one-piece molded ABS cups with 50mm shade 5 filter lens and clear cover glass lens that conforms to the contours of the face. Adjustable nosepiece and headband provides a snug and comfortable fit. Two indirect vents on each side provide effective cooling. Meets ANSI Z87.1



### MODEL 20-1775-5 FIXED FRONT WELDING GOGGLES

Features soft and flexible frame for a snug and comfortable fit over the face or RX glasses. Provided with standard 2" x 4-1/4", shade 5 filter lens and clear cover glass lens in a heat-resistant retainer. Six indirect vents on each side, bottom and top provide effective air flow. Also accommodates magnifier lenses. Meets ANSI Z87.1



### MODEL 20-1710-5 LIFT FRONT WELDING GOGGLES

Features soft and flexible frame for a snug and comfortable fit over the face or RX glasses. Provided with standard 2" x 4-1/4", shade 5 filter lens and clear cover glass lens in a heat resistant retainer. Quick lift front and clear protective lens provides quick change from welding work to the others. Six indirect vents on each side, bottom and top provide effective air circulation. Meet ANSI Z87.1



### REPLACEMENT FILTER AND COVER PLATES

A variety of filter and cover plates are available for welding and other needs. Cover plates are available in 50mm, 2" x 4-1/4" and 4-1/2" x 5-1/4" plastic. Both plastic and glass lenses are available in the same sizes in a variety of shade numbers. GENTEC Filter Plates provide best protection against hazard infrared and ultraviolet rays. GENTEC Cover plates provide ultimate protection of filter lenses. Meet or exceed ANSI Z87.1

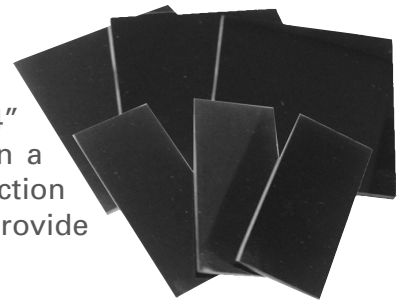

Model Number	Material	Sizes	Shade Available
20-FG24	GLASS	2" x 4-1/4"	4-14
20-FG25	GLASS	4-1/2" x 5-1/4"	4-14
20-FP24	PLASTIC	2" x 4-1/4"	4-14
20-FP45	PLASTIC	4-1/2" x 5-1/4"	4-14
20-FG50	GLASS	50mm	4-6

\*To order, add shade # to the model number (e.g. 20-FG24-04)

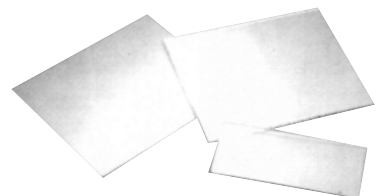
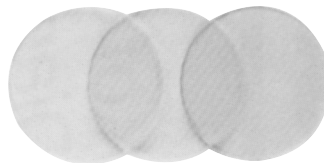

#### Plastic Cover Plates

20-SP24: Size 2" x 4-1/4"

20-SP45: Size 4-1/2" x 5-1/4"

20-SP50: Size 50mm

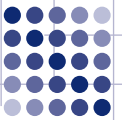

Model Number	PP	Model Number	PP	Model Number	PP	Model Number	PP	Model Number	PP
100QF-F	10	25-121	7	27-CL120	4	27-GC500	3	CK-0	11
100QF-Y	10	25-122	7	27-CL1214	4	27-GCF200C	4	CK-1SP	11
20-1610-5	13	25-130	7	27-CL26	4	27-GCF300C	4	CK-20SP	11
20-1675-5	14	25-300	8	27-CL3040	4	27-GCF500C	4	CK-22SP	11
20-1710-5	14	25-301	8	27-CL4045	4	27-GCR1200	4	CK-24SP	11
20-1775-5	14	25-450	8	27-CL4080	4	27-GCR1200-1	4	CK-26SP	11
20-EP-106	13	25-451	8	27-CL40HD	4	27-GCR2000	4	CK-5SP	11
20-EP-107	13	25-FB14HR	9	27-CL46	4	27-GCR600	4	HW23-012	8
20-FG24	14	25-FP14	9	27-CL62	4	27-GCT200C	3	HW23-020	8
20-FG45	14	25-FSH10	10	27-CL68	4	27-GCT300C	3	HW23-025	8
20-FG50	14	25-FSH30	10	27-CL810	4	27-GCT500C	3	HW23-050	8
20-FP24	14	25-HG-20	7	27-CLC1045	4	27-MCW-3P	7	HW24-025	8
20-FP45	14	25-HG-20WB	7	27-CLC1080	4	27-MP10	6	HW24-050	8
20-G202C	13	25-HG-21WD	7	27-CLC4045	4	27-MP10M	6	HW24-100	8
20-G206C	13	25-HG-30	7	27-CLC4080	4	27-MPD25	6		
20-SP24	14	25-M060P	7	27-CS120	5	27-MPD50	6		
20-SP45	14	25-M061P	7	27-CS3040	5	27-MPD70	6		
20-SP50	14	25-M063P	7	27-CS40HD	5	27-MPD95	6		
24-0007	12	25-M065P	7	27-CS62	5	27-MPD-LDA	6		
24-0008	12	25-TD3	10	27-CSB2040	5	27-NR	10		
24-0009	12	27-0005	7	27-CSB3040	5	28-15SS	8		
24-0010	12	27-0010	7	27-CSB610	5	28-30SS	8		
24-0017	12	27-0020	7	27-CSS120	5	28-B290	8		
24-0018	12	27-0250	7	27-CSS3040	5	28-B387	8		
24-0019	12	27-1013	7	27-CSS40HD	5	28-B387SS	8		
24-0030	12	27-1013L	7	27-CSS62	5	28-B388	8		
24-0031	12	27-118	4	27-CT10FA	6	28-B388SS	8		
24-0044	12	27-118-1	4	27-CT10FS	6	28-BA19	8		
24-0045	12	27-138	4	27-CT40FA	6	28-BAB26	8		
24-0130	12	27-CC10	5	27-CT40FS	6	28-CL402	9		
24-0131	12	27-CC10F	5	27-EH-1	3	28-CL403	9		
24-0769	12	27-CC10M	5	27-EH-2	3	28-CL404	9		
24-3588	12	27-CC40	5	27-EH-25	3	28-CL406	9		
24-4750	12	27-CC40F	5	27-EH-3	3	28-CL408	9		
24-7322	12	27-CC40M	5	27-EH-35	3	28-CL410	9		
24-7323	12	27-CCR10	5	27-EH-50	3	28-CL412	9		
24-7325	12	27-CCR10F	5	27-EHT-2	3	28-CLP06	9		
24-7326	12	27-CCR10M	5	27-EHT-25	3	28-CLP11	9		
24-7327	12	27-CCR40	5	27-EHT-3	3	28-CLV90-1	9		
24-7328	12	27-CCR40F	5	27-EHT-35	3	28-CLV90-2	9		
24-7329	12	27-CCR40M	5	27-EHT-40	3	28-CLW09	9		
24-9116	12	27-CCW1040	5	27-EHT-4TT	3	9-WG1P	13		
24-9940P	12	27-CL1045	4	27-EHT-50	3	9-WG6G	14		
25-110	10	27-CL1080	4	27-GC200	3	C-1	11		
25-120	7	27-CL12	4	27-GC300	3	C-5	11		

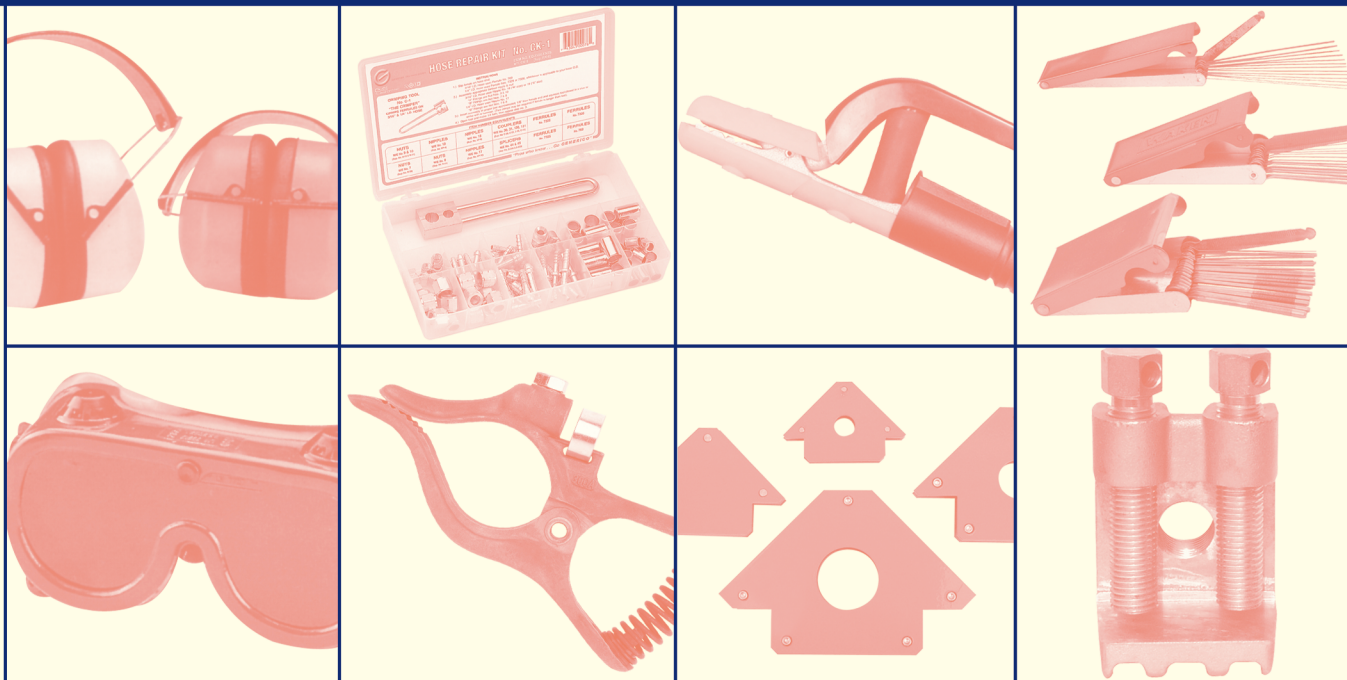

CATALOG#: ACCESS03 V1.1

COPYRIGHT © 2021 Genstar Technologies Co., Inc.

Printed in China

